

RESERVDLSKATALOG
PARTS CATALOGUE

C3-series



VOLVO
 Genuine Parts
 LV 010 53218







NO 212324(S /GB)

VOLVO

EDITION 10-1989

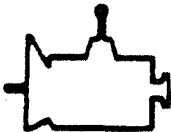
INFÖRDA ÄNDRINGAR
CATALOGUE AMENDMENT

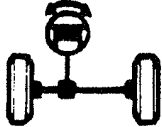
Nr No.	Införd den Inserted on	Nr No.	Införd den Inserted on	Nr No.	Införd den Inserted on
0	06-1974	7	04-1984		
1	04-1976	8	10-1989		
2	12-1976				
3	04-1977				
4	11-1977				
5	03-1979				
6	11-1980				

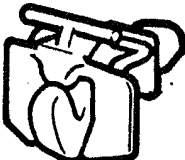
Benämning Description	Kataloggrupp Catalogue group		Sid nr Page No.
KATALOG INDEX CATALOGUE INDEX	INDEX		4- 5
KATALOGTEKNISK INFORMATION CATALOGUE INFORMATION	0 0	???	9- 50
MOTOR MED UPPHÄNGNING OCH UTRUSTNING ENGINE WITH MOUNTINGS AND EQUIPMENT	2 0		57- 131
ELSYSTEM ELECTRICAL SYSTEM	3 0		135- 243
KRAFTÖVERFÖRING POWER TRANSMISSION	4 0		247- 337
BROMS BRAKES	5 0		341- 369
HJULUPPHÄNGNING, STYRNING WHEEL SUSPENSION AND STEERING	6 0		373- 387
RAM, FJÄDRING, DÄMPNING OCH HJUL FRAME, SPRINGS, SHOCK ABSORBERS AND WHEELS	7 0		391- 419
HYTT, INREDNING CAB, INTERIOR	8 0		423- 543
ÖVRIG UTRUSTNING OTHER EQUIPMENT	9 0		547- 567

Grupp		Grupp	
INDEX		KATALOG INDEX	
Sida			
4			
Grupp	Sida	Grupp	Sida
00	<u>KATALOGTEKNISK INFORMATION</u>	9	
01	Förord (S)	9	
02	Förkortningar (S)	17	
03	Nummerregister	23	
04	Register, nya artiklar	43	
05	Kataloginstruktion	49	
20	<u>MOTOR MED UPPHÄNGNING OCH UTRUSTNING</u>	57	
21	Motor	59	
22	Smörjsystem	77	
23	Bränslesystem	81	
25	Inloppssystem	105	
26	Kylsystem	115	
27	Motorreglage	123	
30	<u>ELSYSTEM</u>	135	
31	Batteriupphängning	137	
32	Generator	147	
33	Startmotor	165	
34	Tändsystem	179	
35	Belysning	187	
36	Övrig elektrisk utrustning	199	
37	Ledningar och säkringar	225	
38	Instrumentering	237	
39	Radiosystem	241	
40	<u>KRAFTÖVERFÖRING</u>	247	
41	Koppling	249	
43	Växellåda	253	
45	Kardanaxel	285	
46	Bakaxel	295	
48	Kraftuttag	333	
50	<u>BROMS</u>	341	
51	Hjulbroms	343	
52	Vakuumphyaliskt bromssystem	349	
55	Parkeringsbroms	361	
58	Rörkopplingar, nipplar, Slangar, rör	367	
60	<u>HJULUPPHÄNGNING, STYRNING</u>	373	
61	Framaxel	375	
64	Styrning	381	
70	<u>RAM, FJÄDRING, DÄMPNING OCH HJUL</u>	391	
71	Ram	393	
72	Framfjädring	401	
73	407	
77	Hjul, däck, nav	417	
80	<u>HYTT, INREDNING</u>	423	
81	Karosserisammanställning	425	
83	Dörr	447	
84	Glasruta	459	
85	Inredning	465	
86	Stänkskydd	479	
87	Klimatanläggning	485	
88	Invändig utrustning	519	
89	Övrigt	531	
90	<u>ÖVRIG UTRUSTNING</u>	547	
94	Aggregat för lasthantering	549	
95	Lastbärare	565	

CATALOGUE INDEX

Group

INDEX

Page

5

Group	Page	Group	Page
00	<u>CATALOGUE INFORMATION</u>		9
01	Foreword (GB)		12
02	Abbreviations (GB)		19
03	Numerical register		23
04	Register, new parts		43
05	Catalogue instructions		49
20	<u>ENGINE WITH MOUNTINGS AND EQUIPMENT</u>		57
21	Engine		59
22	Lubricating system		77
23	Fuel system		81
25	Inlet system		105
26	Cooling system		115
27	Engine controls		123
30	<u>ELECTRICAL SYSTEM</u>		135
31	Battery mountings		137
32	Alternator		147
33	Starter motor		165
34	Ignition system		179
35	Lighting		187
36	Other electrical equipment		199
37	Wiring and fuses		225
38	Instrumentation		237
39	Radio system		241
40	<u>POWER TRANSMISSION</u>		247
41	Clutch		249
43	Gearbox		253
45	Propeller shaft		285
46	Rear axle		295
48	Power take-off		333
50	<u>BRAKES</u>		341
51	Wheel brake		343
52	Vacuum-hydraulic brakes		349
55	Parking brake		361
58	Pipe unions, nipples, Hoses, pipe		367
60	<u>WHEEL SUSPENSION AND STEERING</u>		373
61	Front axle		375
64	Steering		381
70	<u>FRAME, SPRINGS, SHOCK ABSORBERS AND WHEELS</u>		391
71	Frame		393
72	Front suspension		401
73		407
77	Wheels, tyres, hubs		417
80	<u>CAB, INTERIOR</u>		423
81	Body assembly		425
83	Door		447
84	Windows		459
85	Interior trim		465
86	Mudflaps		479
87	Heating and ventilation		485
88	Interior equipment		519
89	Other		531
90	<u>OTHER EQUIPMENT</u>		547
94	Load handling unit		549
95	Load carrier		565

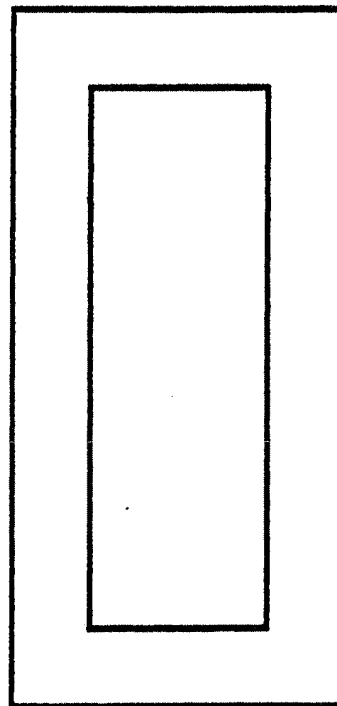
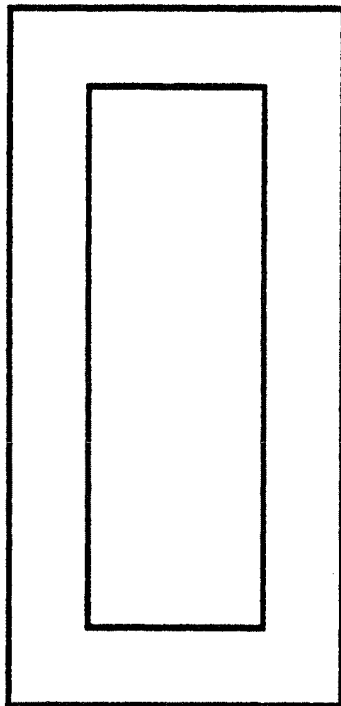

KATALOGTEKNISK INFORMATION

	Sida
01 Förord (S)	9
02 Förkortningar (S)	17
03 Nummerregister	23
04 Register, nya artiklar	43
05 Kataloginstruktion	49

CATALOGUE INFORMATION

	Page
01 Foreword (GB)	12
02 Abbreviations (GB)	19
03 Numerical register	23
04 Register, new parts	43
05 Catalogue instructions	49

FÖRORD (S) / FOREWORD (GB)

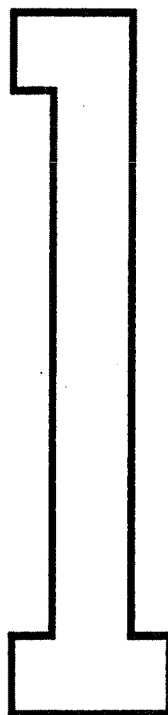
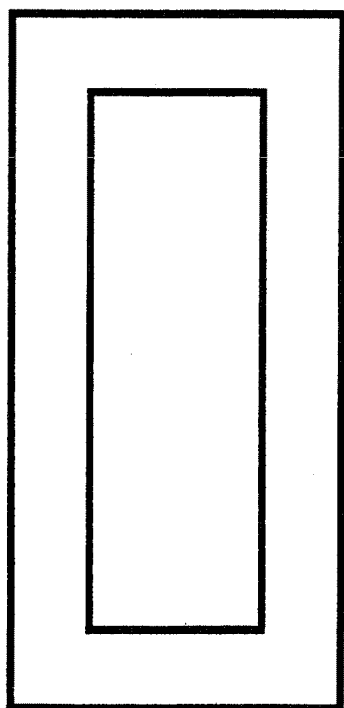

FÖRORD (S)

Grupp

01

Sida

9

Denna katalog upptar reservdelar för vår terrängvagnserie C3.

MODELLBETECKNING: Vagnarnas modellbeteckning framgår av nedanstående:

C 303 4x4 VSTHjulbas
2300.**C 303 4x4 HST**Hjulbas
2300.**C 304 4x4 HST**Hjulbas
2530.**C 303 6x6 VST**Hjulbas
2720.**C 306 6x6 VST (TGB 20)**Hjulbas
2720.**C 306 6x6 HST**Hjulbas
2720.

Terrängvagn version 3, 4 och 5 (se produktskylt) har i anmärkningskolumnen märkts CIVIL.

Speciella detaljer avsedda för Svenska Arméns terrängvagn 20 har i anmärkningskolumnen märkts TGB 20.

MOTOR: Vagnarna är utrustade med motor B 30 A, se grupp 20.

VÄXELLÅDA: Vagnarna är utrustade med växellåda, typ:

S4-18/3 manuell 4 växlar,
S5-18/3 manuell 5 växlar.

SKYLTAR: Placering av skyltar för modell- och motorbeteckning etc., se nästa sida.

FÖRKORTNINGAR: Förklaring till använda förkortningar i katalogen finns i grupp 02.

SPECIALUTFÖRANDE: Se nästa sida.

RESERVEDELSKATALOG C3 kan beställas från

Volvo Group Support AB
Publikationsförrådet
SA A 5510
405 08 Göteborg
under nummer:**Språk**
Svenska/Engelska**Papper**
212324**Fiche**
212325

VOLVO PARTS AB
Avd 33620, VAK HA1S
405 08 Göteborg, Sverige
Tel: 031 / 662539

Grupp	FÖRORD (S)
01	
Sida	
10	

SPECIALUTFÖRANDE: I katalogen har även följande specialutföranden inarbetats:

S-3619 Svenska Statens Vattenfallsverk, 24 V.	8913 Dragkrok.
S-3656 Svenska Statens Vattenfallsverk, 12 V.	8914 Varningstriangel.
S-3652 Zambia, 12 V.	8915 Trålist för lastutrymme.
S-3653 Zambia, 24 V.	8916 Lastförskjutningsskydd.
S-3692 Etiopien.	8917 Lastförskjutningsskydd.
S-3694 Terrängvagn i civilt utförande.	8918 Kupé- och motorvärmare.
S-3695 Terrängvagn i civilt utförande.	8919 Kraftuttag.
S-3696 Terrängvagn i civilt utförande.	8920 Eldriven luftkompressor.
S-3697 Terrängvagn i civilt utförande.	8921 7-polig släpvagnskontakt.
S-3698 Terrängvagn i civilt utförande.	8922 Förbandskudde.
S-3699 Terrängvagn i civilt utförande.	8923 Brandsläckare.
S-3700 Terrängvagn i civilt utförande.	8924 Elektrisk motorvärmare.
S-3701 Terrängvagn i civilt utförande.	8925 Uttag för elektrisk kupévärmare.
S-3705 Bangladesh.	8926 Främre linledare.
S-3736 Svenska Statens Vägverk.	8929 Dragkrok med dragbalk.
S-3758 Polisutförande, Malaysia.	8930 Reservdunkshållare.
S-3761 Peru.	8931 Extra isolering och beklädnad.
S-3780 Angola, Sverige.	8932 AM-FM Radio.
S-3781 Australien.	8933 AM-FM Stereoradio.
S-3802 Svenska Statens Vattenfallsverk.	8934 Ventilation.
S-3853 Svenska Statens Vattenfallsverk.	8935 Dragbalk med dragkula.
S-6059 Svenska Statens Vattenfallsverk.	8936 Laststrålkastare.
	8937 Laststrålkastare.
	8938 Roterande ljus, gult sken.
	8939 Roterande ljus, gult sken.
	8940 Roterande ljus, blått sken.
	8941 Roterande ljus, blått sken.
	8942 Roterande ljus, rött sken.
	8943 Roterande ljus, rött sken.
	8944 Roterande ljus, gult sken.
	8945 Roterande ljus, gult sken.
	8946 Roterande ljus, blått sken.
	8947 Roterande ljus, blått sken.
	8952 Roterande ljus, rött sken.
	8953 Roterande ljus, rött sken.
	8954 Elektrisk kupévärmare.
	8955 Gummimatta bakre golv.
	8956 Dragbalk med 50 mm kula.
	8957 Slirskydd.

FÖRORD (S)

Grupp

01

Sida

11

MODELL OCH CHASSINUMMER

Typ	C03-4-4-3-V	
Ch. No.	2046	
Hjulbas	2300	mm
Tot. vikt	3300	kg
Gr. löden vikt		
S-3698	8923	
VOLVO GÖTTENIC SWEDEN		

MOTORBETECKNING

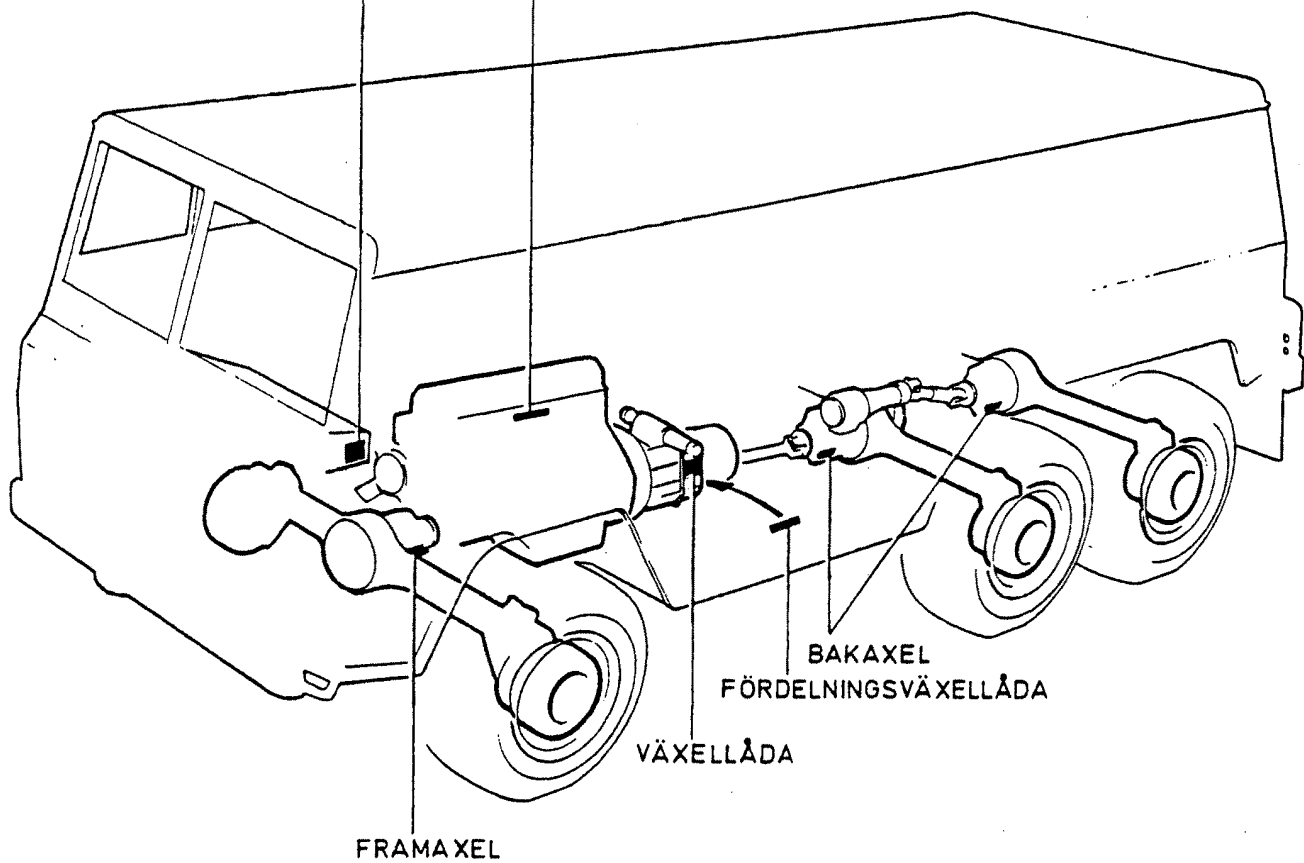

VOLVO
Genuine Parts
LV 011 53219

Group

01

FOREWORD (GB)

Page

12

This catalogue lists part for the C3 cross country vehicle series.

TYPE DESIGNATION: Type designations of vehicle are as follows:

C 303 4x4 VST

Wheelbase
2300.

C 303 4x4 HST

Wheelbase
2300.

C 304 4x4 HST

Wheelbase
2530.

C 303 6x6 VST

Wheelbase
2720.

C 306 6x6 VST (TGB 20)

Wheelbase
2720.

C 306 6x6 HST

Wheelbase
2720.

Version 3, 4 and 5 of the cross country vehicle (see the designation plate) have been marked CIVIL in the notes column.

Parts special for the Swedish military cross country vehicle Type 20 are marked TGB 20 in the notes column.

ENGINE: The vehicles are equipped with engine type B 30 A, see group 20.

GEARBOX: The vehicles are equipped with gearboxes type:

S4-18/3 manual 4-speed,
S5-18/3 manual 5-speed.

PLATES: The location of the designation plates for type and engine designations, etc. is illustrated on the next page.

ABBREVIATIONS: A clarification of abbreviations used in the catalogue will be found in group 02.

SPECIAL MODELS: See next page.

THE PARTS CATALOGUE for the C3 can be ordered from

Volvo Group Support AB
Publications Store
SA A 5510
S-405 08 Göteborg, Sweden
Order nummer:

Language
Swedish/English

Paper
212324

Fiche
212325

VOLVO PARTS CORPORATION
Dept 33620, VAK HA1S
S-405 08 Göteborg, Sweden
Tel: 46 - 31662539

FOREWORD (GB)

Group

01

Page

13

SPECIAL MODELS: The following special models are also listed in the catalogue:

S-3619	The state power department of Sweden, 24 V.	8913	Towing hook.
S-3656	The state power department of Sweden, 12 V.	8914	Advance warning triangle.
S-3652	Zambia, 12 V.	8915	Wooden strips for cargo space.
S-3653	Zambia, 24 V.	8916	Cargo displacement protection.
S-3692	Ethiopia.	8917	Cargo displacement protection.
S-3694	Cross country truck (cevilian).	8918	Compartment and engine heater.
S-3695	Cross country truck (cevilian).	8919	Power take-off.
S-3696	Cross country truck (cevilian).	8920	Electric air compressor.
S-3697	Cross country truck (cevilian).	8921	7-pole trailer socket.
S-3698	Cross country truck (cevilian).	8922	First-aid cushion.
S-3699	Cross country truck (cevilian).	8923	Fire extinguisher.
S-3700	Cross country truck (cevilian).	8924	Electric engine heater.
S-3701	Cross country truck (cevilian).	8925	Socket for electric compartment heater.
S-3705	Bangladesh.	8926	Forward cable guide.
S-3736	National Swedish Highway Authority.	8929	Towing hook with towing member.
S-3758	Malayan Police.	8930	Spare fuel can holder.
S-3761	Peru.	8931	Extra insulation and upholstery.
S-3780	Angola, Sweden.	8932	AM-FM Radio.
S-3781	Australia.	8933	AM-FM Stereoradio.
S-3802	The state power department of Sweden.	8934	Ventilation.
S-3853	The state power department of Sweden.	8935	Towbar.
S-6059	The state power department of Sweden.	8936	Loading lamp.
		8937	Loading lamp.
		8938	Rotating lamp, yellow.
		8939	Rotating lamp, yellow.
		8940	Rotating lamp, blue.
		8941	Rotating lamp, blue.
		8942	Rotating lamp, red.
		8943	Rotating lamp, red.
		8944	Rotating lamp, yellow.
		8945	Rotating lamp, yellow.
		8946	Rotating lamp, blue.
		8947	Rotating lamp, blue.
		8952	Rotating lamp, red.
		8953	Rotating lamp, red.
		8954	Electric compartment heater.
		8955	Rubber mats for rear floor.
		8956	Towbar with 50 mm ball.
		8957	Anti-slip chain.

Group

01

Page

14

FOREWORD (GB)

MODEL DESIGNATION AND CHASSIS NUMBER

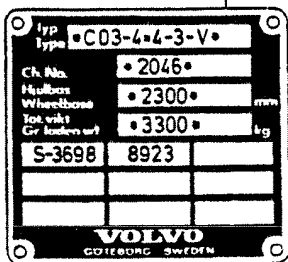

ENGINE DESIGNATION

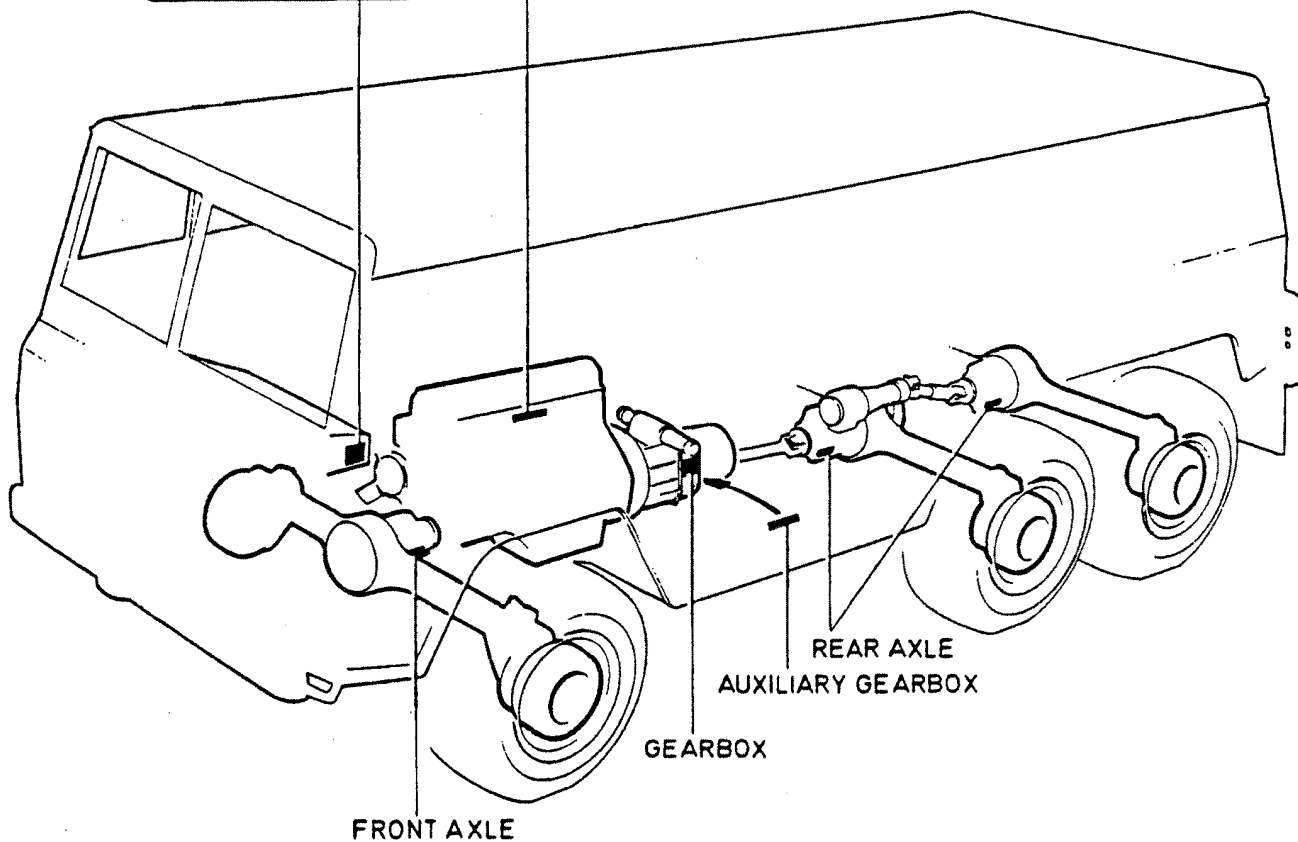

VOLVO
Genuine Parts
LV 011 53220